

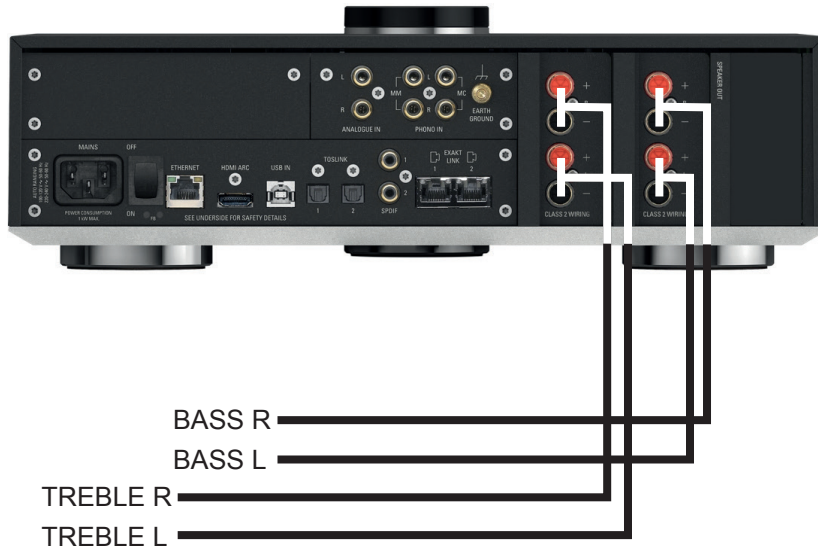

LINN SELEKT CAN BE CONFIGURED IN NUMEROUS WAYS. PLEASE CHECK WITH YOUR DEALER, LINNDOCS AND LINN KONFIG, FOR YOUR SPECIFIC SYSTEM AND REQUIREMENTS.

KUDOS SUPER10A, SUPER20A, TITAN506/607 & 707



KUDOS TITAN808

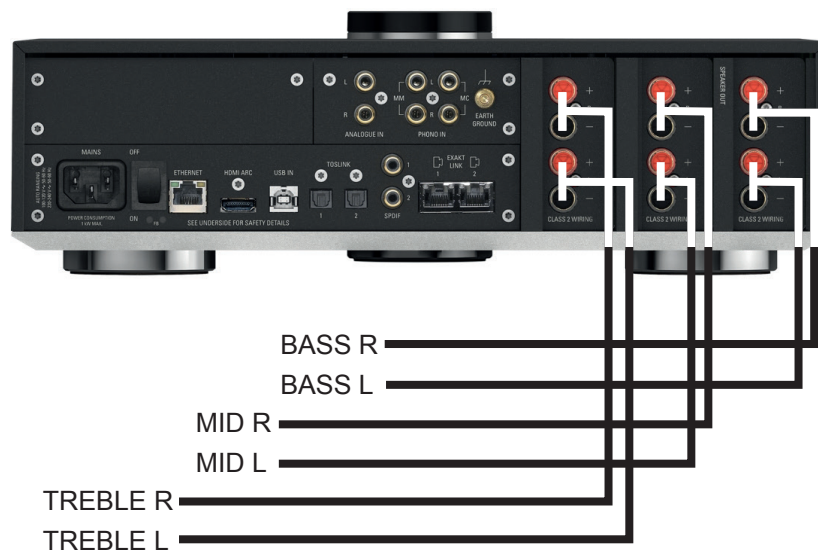

NOTE THIS IS JUST A GUIDE. LINN CAN MAKE CHANGES AT ANY TIME. PLEASE CHECK WITH LINN KONFIG FOR THE LATEST CORRECT WIRING. KUDOS AUDIO DOES NOT ACCEPT RESPONSIBILITY FOR DAMAGE TO SPEAKERS OR ELECTRONICS. IF IN DOUBT CONSULT YOUR DEALER.



KUDOS CARDEA SUPER 10A

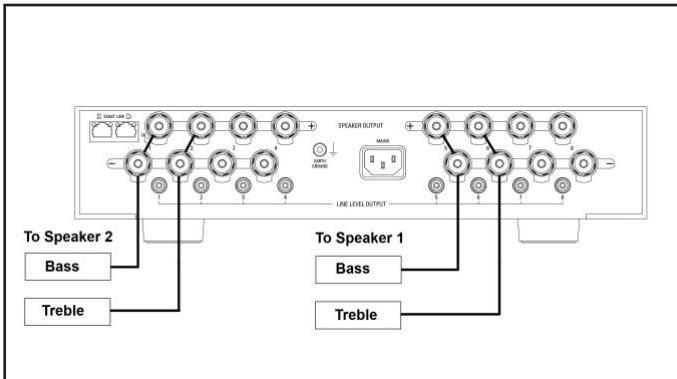

KUDOS CARDEA SUPER 20A

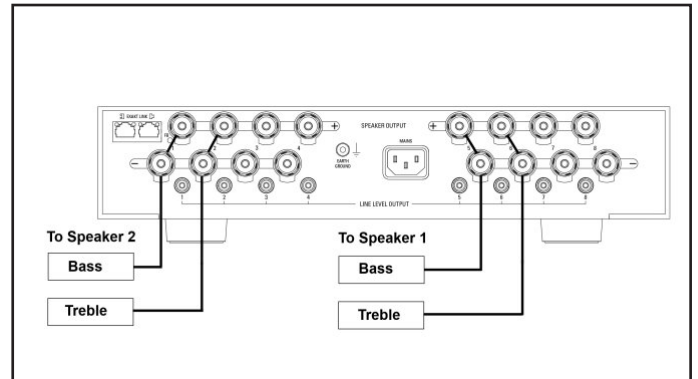

KUDOS TITAN 505

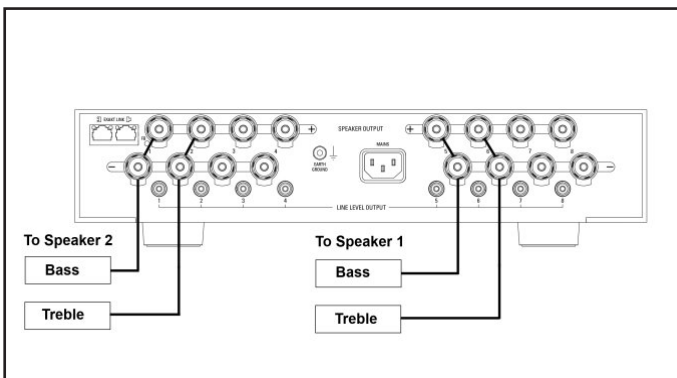

KUDOS TITAN 606

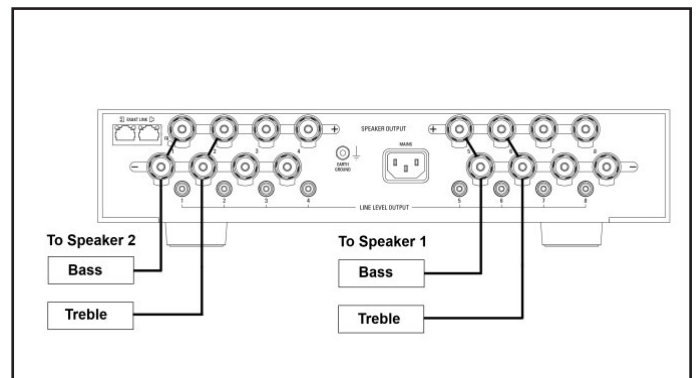

KUDOS TITAN 707

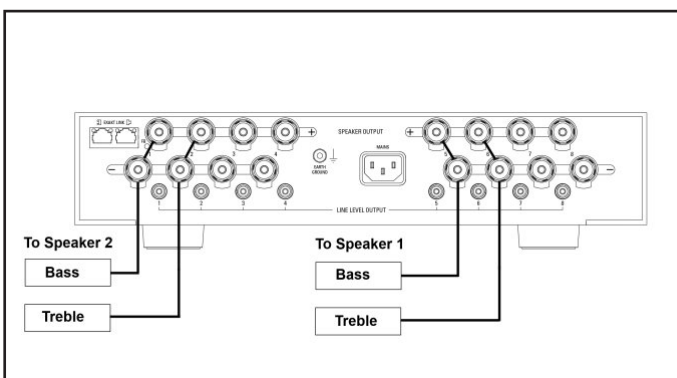

KUDOS TITAN 808

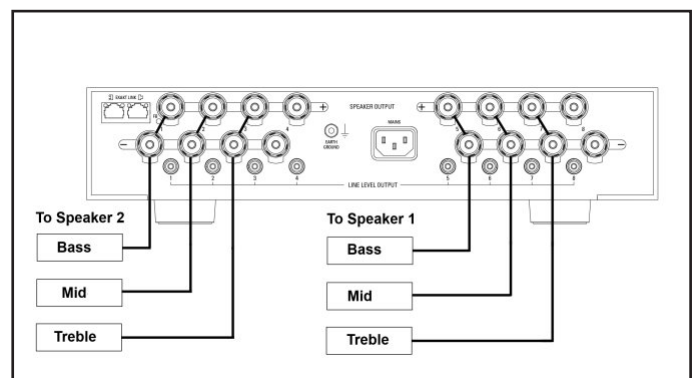

NOTE THIS IS JUST A GUIDE. LINN CAN MAKE CHANGES AT ANY TIME. PLEASE CHECK WITH LINN KONFIG FOR THE LATEST CORRECT WIRING. KUDOS AUDIO DOES NOT ACCEPT RESPONSIBILITY FOR DAMAGE TO SPEAKERS OR ELECTRONICS. IF IN DOUBT CONSULT YOUR DEALER.



KUDOS CARDEA SUPER 10A

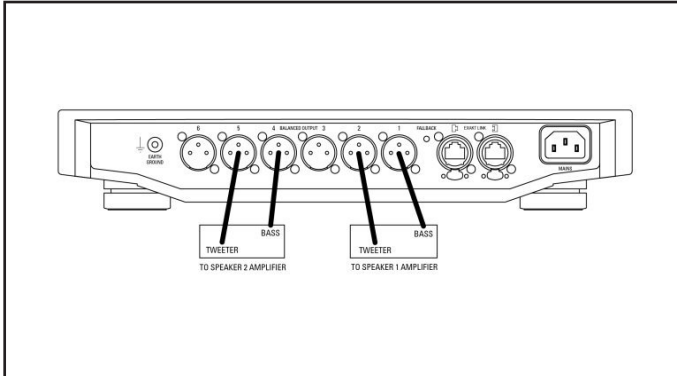

KUDOS CARDEA SUPER 20A

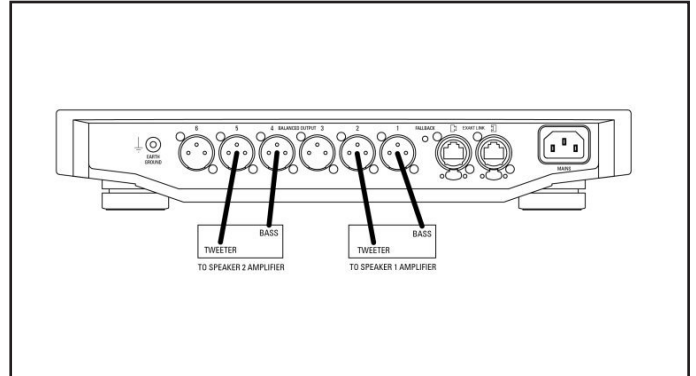

KUDOS TITAN 505

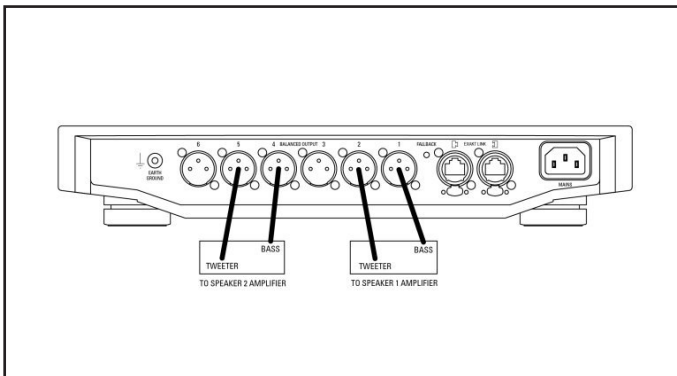

KUDOS TITAN 606

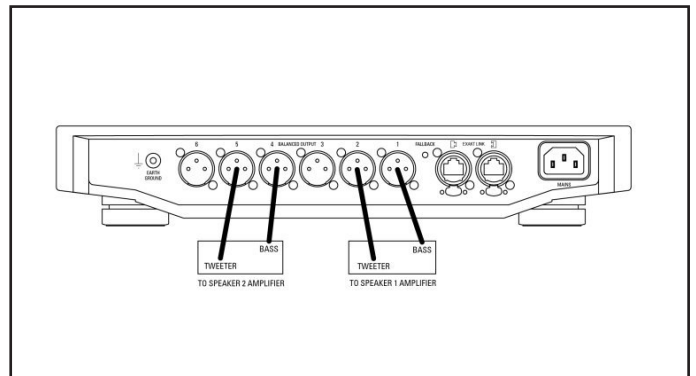

KUDOS TITAN 707

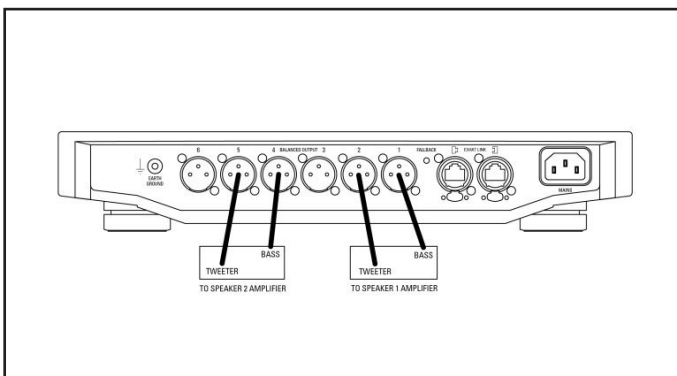

KUDOS TITAN 808

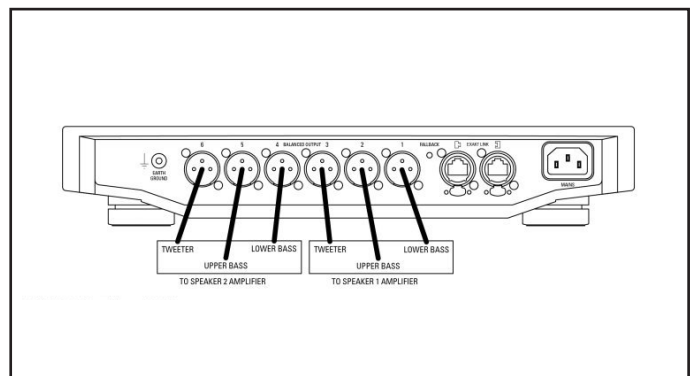

NOTE THIS IS JUST A GUIDE. LINN CAN MAKE CHANGES AT ANY TIME. PLEASE CHECK WITH LINN KONFIG FOR THE LATEST CORRECT WIRING. KUDOS AUDIO DOES NOT ACCEPT RESPONSIBILITY FOR DAMAGE TO SPEAKERS OR ELECTRONICS. IF IN DOUBT CONSULT YOUR DEALER.